

FEATURES

- 2 channels for R L C loads and for Dimmable CFL and LED lamps
- Automatic detection of R L C load type
- Automatic frequency detection
- Dimming pattern selection for CFL and LED lamps
- Optional manual Dimming control
- 2 Analog/Digital inputs
- Total data saving on KNX bus failure
- Integrated KNX BCU (TP1-256)
- Dimensions 67 x 90 x 79 mm (4.5 DIN units)
- DIN rail mounting according to IEC 60715 TH35, with fixing clamp
- Conformity with the CE, UKCA, RCM directives (marks on the right side)

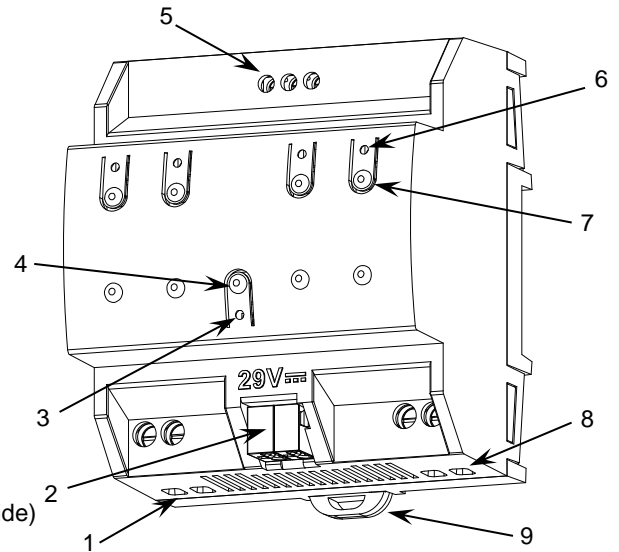

Figure 1: DIMinBOX DX2

1. Power supply input	2. KNX connector	3. Programming/Test LED	4. Programming/Test button
5. Analog/Digital inputs	6. Output status LED	7. Output control button	8. Output channels
			9. Fixing clamp

Programming/Test button: short press to set programming mode. If this button is held while plugging the device into the KNX bus, it enters the safe mode. If this button is held for more than 3 seconds, the device enters the test mode.

Programming/Test LED: programming mode indicator (red). When the device enters the safe mode, it blinks (red) every half second. The manual mode is indicated by the green color. During the start-up (reset or after KNX bus failure) and if the device is not in safe mode, it emits a red flash.

GENERAL SPECIFICATIONS

CONCEPT		DESCRIPTION		
Type of device		Electric operation control device		
KNX supply	Voltage (typical)	29 VDC SELV		
	Voltage range	21-31 VDC		
	Maximum consumption	Voltage	mA	mW
		29 VDC (typical)	11	319
24 VDC ¹	15	360		
Connection type		Typical TP1 bus connector for 0.8 mm Ø rigid cable		
External power supply		110-230 VAC 50/60 Hz		
Operation temperature		0 .. +55 °C		
Storage temperature		-20 .. +55 °C		
Operation humidity		5 .. 95%		
Storage humidity		5 .. 95%		
Complementary characteristics		Class B		
Protection class		II		
Operation type		Continuous operation		
Device action type		Type 1		
Electrical stress period		Long		
Degree of protection		IP20, clean environment		
Installation		Independent device to be mounted inside electrical panels with DIN rail (IEC 60715)		
Minimum clearances		Not required		
Response on KNX bus failure		Data saving according to parameterization		
Response on KNX bus restart		Data recovery according to parameterization		
Operation indicator		The programming LED indicates programming mode (red) and test mode (green). Each output LED indicates its status (fixed = active output; flashing = error in the output)		
Weight		210 g		
PCB CTI index		175 V		
Housing material		PC FR V0 halogen free		

¹ Maximum consumption in the worst-case scenario (KNX Fan-In model).

OUTPUTS SPECIFICATIONS AND CONNECTIONS			
CONCEPT		DESCRIPTION	
Number of outputs		2	
Output type		Solid state switching device	
Short-circuit protection		YES	
Overload protection		YES	
Connection method		Screw terminal block (0.5 Nm max.)	
Cable cross-section		1.5-4 mm ² (IEC) / 26-10 AWG (UL)	
LOADS AND ALLOWED POWER (@ 35 °C ambient temperature around the device)			
		230 VAC	110 VAC
RLC	Individual channels	Up to 310 W	Up to 200 W
	Common channel	Up to 600 W	Up to 400 W
CFL and LED ¹	Individual channels	Up to 310 W	Up to 200 W
	Common channel	Up to 600 W	Up to 400 W

¹For leading edge, the maximum load could change depending on the load type. Please refer to the link https://zennio.com/download/technical_note_diminbox-dx_list_process_en.

Also, for load characterization process, please refer to the link https://www.zennio.com/download/technical_note_diminbox-dx2_tests_en.

EXTERNAL POWER SUPPLY SPECIFICATIONS AND CONNECTIONS			
CONCEPT		DESCRIPTION	
Power supply protection fuse	Voltage	250 V	
	Current	10 A	
	Response type	F (Fast acting)	
Connection method		Screw terminal block (0.5 Nm max.)	
Cable cross-section		1.5-4 mm ² (IEC) / 26-10 AWG (UL)	

WIRING DIAGRAMS

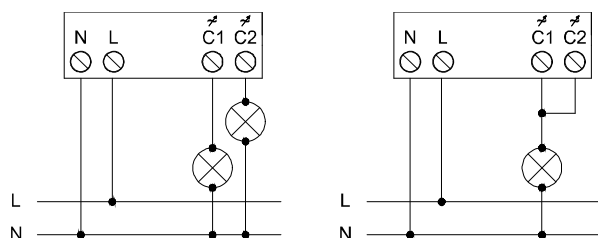
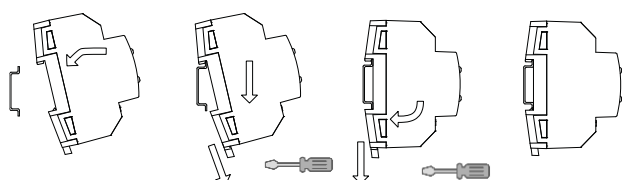

Figure 2: Wiring examples (independent channels and common channel connection)

Attaching DIMinBOX DX2 to DIN rail:



Removing DIMinBOX DX2 from DIN rail:

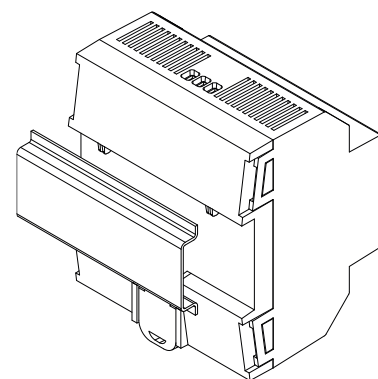
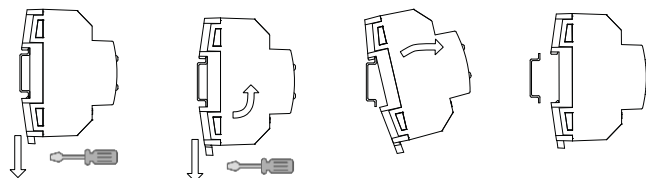

Figure 3. Mounting DIMinBOX DX2 on DIN rail

SAFETY INSTRUCTIONS AND ADDITIONAL NOTES

- Installation should only be performed by qualified professionals according to the laws and regulations applicable in each country.
- Do not connect the mains voltage nor any other external voltage to any point of the KNX bus; it would represent a risk for the entire KNX system. The facility must have enough insulation between the mains (or auxiliary) voltage and the KNX bus or the wires of other accessories, in case of being installed.
- The facility must be equipped with a device that ensures the omnipolar sectioning. Installation of a 10 A mini-circuit-breaker is recommended. To prevent accidents, it must remain open in case of manipulation of the device.
- The device has a short-circuit protection fuse that, in case of activation, should only be rearmed or replaced by the Zennio technical service.
- Once the device is installed (in the panel or box), it must not be accessible from outside.
- Keep the device away from water (condensation over the device included) and do not cover it with clothes, paper or any other material while in use.
- The WEEE logo means that this device contains electronic parts and it must be properly disposed of by following the instructions at <https://www.zennio.com/en/legal/weee-regulation>.

SUPPORTED LOADS

- R = Resistive
- L = Inductive
- C = Capacitive
- CFL = Dimmable Compact Fluorescent Lamps
- LED = Dimmable LED lamps

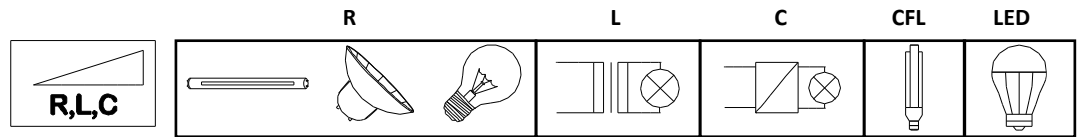

! Please, make sure that the loads used are dimmable.

LOAD COMBINATION

- In case of combining resistive (R) with inductive (L) loads, the resistive loads must not exceed the 50% of the total power.
- In case of combining resistive (R) with capacitive (C) loads, the resistive loads must not exceed the 50% of the total power.
- **Combination of capacitive loads with inductive loads is NOT ALLOWED.**
- Do not combine CFL or LED lamps with R L C loads.
- It is not advisable to combine different models of CFL lamps, LED lamps or transformers in the same channel since correct operation can be affected.

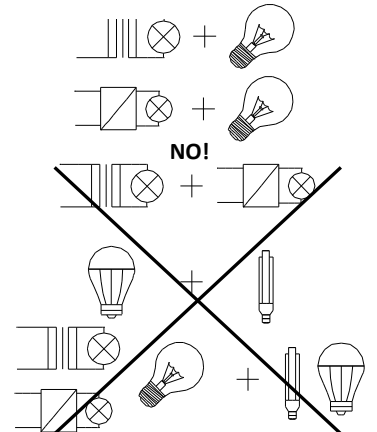

OVERHEATING PROTECTION

- When the ambient temperature is too high the dimmer actuator will regulate itself, at a maximum of 20%.
- Once the ambient temperature decreases, the dimmer actuator will resume its normal operation. Please, refer to user manual.

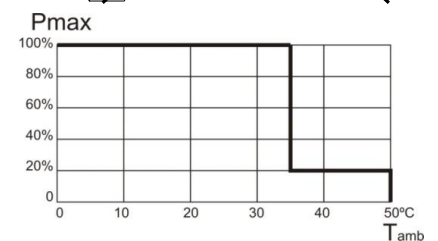

INPUTS SPECIFICATIONS AND CONNECTIONS

CONCEPT	DESCRIPTION
Number of inputs	2
Inputs per common	2
Operation voltage	+3.3 VDC in the common
Operation current	1 mA @ 3.3 VDC (per input)
Switching type	Dry voltage contacts between input and common
Connection method	Screw terminal block (0.5 Nm max.)
Cable cross-section	0.5-2.5 mm ² (IEC) / 26-12 AWG (UL)
Maximum cable length	30 m
NTC probe length	1.5 m (extensible up to 30 m)
NTC accuracy (@ 25 °C) ²	±0.5 °C
Temperature resolution	0.1 °C
Maximum response time	10 ms

² For Zennio temperature probes.

INPUTS CONNECTION

Any combination of the following accessories is allowed in the inputs:

Temperature Probe**

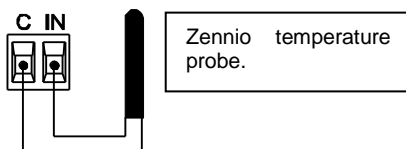

Motion Sensor

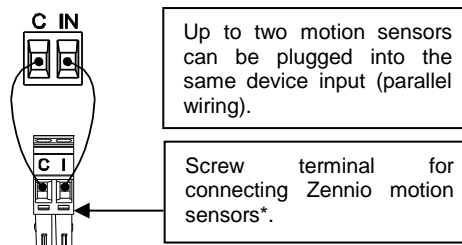

Switch/Sensor/ Push button

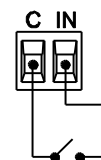

! Commons of different devices must not be connected together.

* In case of using ZN110-DETEC-P sensor, its micro switch number 2 must be in **Type B position**.

** Zennio temperature probe or any NTC with known resistance values at three points in the range [-55, 150 °C].

ERROR NOTIFICATIONS

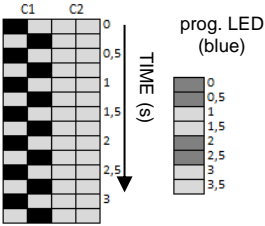
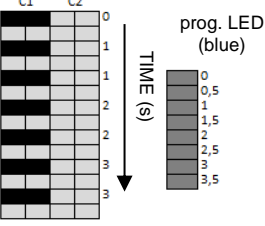
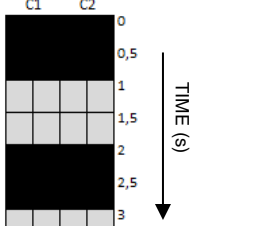
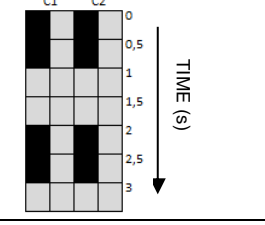
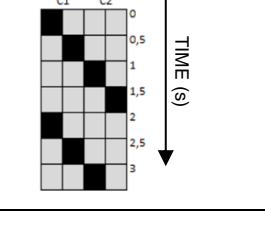
ERROR	LED BEHAVIOR	VISUAL NOTIFICATION
Short circuit	<p>The two status LEDs of the channel with the error blink alternately every 0.25 second.</p> <p>When the output is locked, the programming LED blinks in blue.</p>	<p>CHANNEL</p> 
Voltage Surge	<p>The two status LEDs of the channel with the error blink simultaneously each 0.25 seconds.</p> <p>When the output is locked, the programming LED lights in blue.</p>	<p>CHANNEL</p> 
Overheating	<p>The LEDs blink every second.</p>	<p>CHANNEL</p> 
Supply Voltage Failure	<p>One LED of each channel blinks every second.</p>	<p>CHANNEL</p> 
Anomalous Frequency	<p>All the LEDs of each channel blinks (during two seconds) sequentially</p>	<p>CHANNEL</p> 
Parameterization Error	<p>One LED of the channel blink every second while the other LED blinks every 0.25 seconds.</p>	<p>CHANNEL</p> 